

ITSD-23

ITS Series Generators



Features and Benefits

- Many years of experience in generator construction
- Diesel Engines with Advanced Technology and Quality
- Alternators with Advanced Technology and Quality
- Control Panel Suitable for Flexible Application
- High Quality and Reliable Technology
- Patented Compact Designed and Soundproof Canopy
- Suitable for Heavy-Duty
- Durability
- Wide Range of Affordable Spare Parts
- Low Noise Level
- Low Exhaust Emission
- Low Operating Cost
- Low Fuel Consumption
- Low Oil Consumption
- Tropical 50°C Radiator
- Fuel Filter with Water and Particle Separator
- First Class Product Support
- Global Technical Service and Maintenance Support



Generator General Information

Generator	Frequency	Voltage	Power Factor	Speed	Diesel Engine		Alternator			Type of	Generator Output		
Model	Hz	V	CosQ	rpm	Brand	Model	Brand	Model	Series	Operation	kVA	kW	A
ITSD-23	50	231/400	0,8	1500	INTER	M28D	GNP	GNP	160LX	Stand By	23,0	18,4	33,2
										Prime	20,9	16,7	30,2
										Continuous	14,6	11,7	21,2

* ITS POWER GENERATORS reserves its right to change the specifications and cabin sizes in advance due to the continuing developments in the generator technology without any prior notification.

INTER Diesel Engine Technical Parameters and Matching Parameters

Diesel Engine Main Technical Parameters

General

Number of Cylinders		4
Configuration		Vertical, In Line
Aspiration		Naturally
Combustion System		Direct Injection
Compression Ratio		19.1:1
Bore	mm	85
Stroke	mm	100
Displacement	L	2,27
Governing Type		Mechanic
Governing Class		G2
Rotation		Counterclockwise
Firing Order		1-3-4-2
Emission		Tier II

Filters

Air Filter		Dry Type, Replaceable
Fuel Filter		With Water Separator
Oil Filter		Element Type, Particulate Trap

Electrical System

Voltage	V	12
Starter	kW	3,2
Alternator Output Amperes	A	25
Alternator Output Voltage	V	14
Batteries Capacity	Ah	55

Fan

Diameter	mm	410
Drive Ratio		1,61:1
Number of Blades		7
Material		Plastic
Type		Blowing

Cooling System

Radiator Type	50°C	Tropical
Total Coolant Capacity	L	13
Max. Perm. Coolant Outlet Temperature	°C	103
Max. Perm. Flow Resis. (Cool. System And Piping)	bar	0,5
Max. Temperature of Coolant Warning	°C	95
Max. Temperature of Coolant Shutdown	°C	98
Thermostat Operation Temperature - Initial Open	°C	68
Thermostat Operation Temperature - Full Open	°C	72
Delivery of Coolant Pump	m ³ /h	1,60
Min. Pressure Before Coolant Pump	bar	0,15
Radiator Face Area	m ²	0,21
Rows	Row	2
Matrix Density	Per / Inch	15,5
Material		Aluminum
Width of Matrix	mm	438
Height of Matrix	mm	480
Pressure Cap Setting k	Pa	90
Estimated Cooling Air Flow Reserve	kPa	0,125
Engine Pre Heater Tube (with Circulation Pump)	W	1500

Lubrication System

Total System	L	8
Minimum Oil Level	L	7
Nominal Motor Operating Temperature	°C	40
Lubricating Oil Pressure (Rated Speed)	bar	5
Relief Valve Opens	kPa	352
Oil / Fuel Consumption Ratio	%	≤0,3
Normal Oil Temperature	°C	110

Diesel Engine Matching Parameters

50 Hz @ 1500 r/min		Stand By	Prime
Gross Engine Power	kW	23,5	21,4
Net Engine Power	kW	21,5	19,9
Fan Power Consumption (Belt Pulley Driven)	kW	1,5	1,5
Other Power Loss	kW	0,5	0,5
Mean Effective Pressure	MPa	0,83	0,75
Intake Air Flow	m ³ / min	1,25	1,25
Exhaust Temperature Limit	°C	300	300
Exhaust Flow	m ³ / min	1,30	1,15
Boost Pressure Ratio		3,80	3,40
Mean Piston Speed	m / s	5,0	5,0
Cooling Fan Air Flow	m ³ / min	46,6	46,6
Typical Generator Output Power	kVA	23	21

Heat Rejection		Stand By	Prime
Energy In Fuel (Heat Of Combustion)	kW	63,0	54,4
Gross Heat To Power	kW	23,5	21,4
Energy To Coolant And Lubricating Oil	kW	19,2	16,1
Heat Dissipation Capacity*	kW	-	-
Energy To Exhaust	kW	16,1	13,1
Heat To Radiation	kW	4,2	3,8

*Intake Intercooled System

ITS POWER GENERATORS Alternator Technical Parameters and Specifications

Alternator Technical Parameters

Insulation Class		H
Winding Pitch		2/3 - (N° 6)
Wires		12
Protection		IP 23
Altitude	m	1000
Overspeed	rpm	2250
Air Flow	m ³ /sec	0.071
Bearing Drive	N/A	-
Rotor Winding	100%	Copper

Field Control System		Self excited
A.V.R. Model	Standard	SX460
Voltage Regulation	%	± 1
Sustained Short-Circuit Current	10 sec	300% (3 IN)
Total Harmonic (*) TGH / THC	%	< 5
Wave Form :NEMA = TIF - (*)		< 50
Wave Form :I.E.C. = THF - (*)	%	< 2
Bearing Non - Drive	Bearing	6306-2RZ
Stator Winding	100%	Copper

(*) Total harmonic content line to line, at no load or full rated linear and balanced load

ITS POWER GENERATORS synchron alternators are produced according to TSE 60034-1; IEC 60034-22; GB755; BS4999-5000; NEMA MG 1.22 standards

* ITS POWER GENERATORS reserves its right to change the specifications and cabin sizes in advance due to the continuing developments in the generator technology without any prior notification.

Alternator Specifications

50 Hz - 231/400V - Cos Q 0,8 - 1500 rpm

Standard Using Alternator			Optional Using Alternator						
Brand/Model	ITS POWER	160LX	Leroy Somer	TAL040F	Stamford	SOL2G			
Duty		Continuous				Stand By			
Ambient	C°	40°C				27°C			
Class/Temp. Rise	C°	H / 125° K				H / 163° K			
Series Star (V)	V	380/220	400/231	415/240	1 Phase	380/220	400/231	415/240	1 Phase
Parallel Star (V)	V	190/110	200/115	208/120	220	190/110	200/115	208/120	220
Series Delta (V)	V	220	230	240	230	220	230	240	230
Output Power	kVA	21,0	21,0	22,0	14,0	23,0	23,0	24,0	15,0
Output Power	kW	16,8	16,8	17,6	11,2	18,4	18,4	19,2	12,0

Generator Dimensions

Values		Open Type Generator	Canopy Type Generator
Width	mm	597	1000
Length	mm	1400	2000
Height	mm	1309	1190
Weight (Net)	Kg	537	680
Fuel Tank Capacity	L	58	100

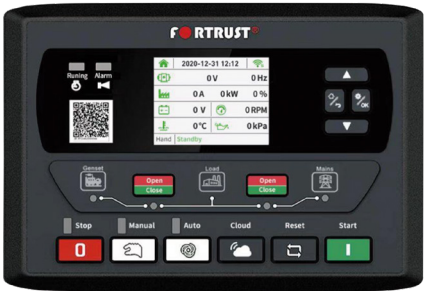

Control operator / Display panel

Generator Technical Drawings

SYMBOL	OPEN	CANOPY
L	1400	2000
M	597	1000
H	1309	1190
W	428	450
Z	529	550
X	428	450
C	450	450
D1	500	500
D2	500	500
D3	450	450
D4		
D5		

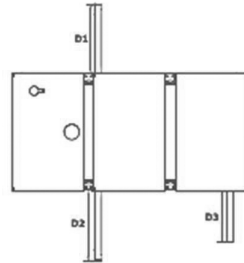
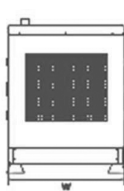
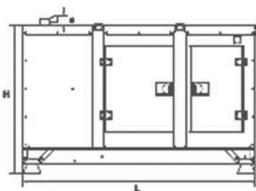
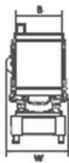
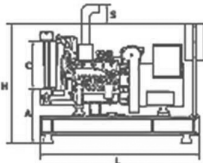

* ITS POWER GENERATORS reserve its right to change the specifications and cabin sizes in advance due to the continuing developments in the generator technology without any prior notification.

Diesel Engine and Genset Rating Classifications

The below ratings represent the engine performance capabilities to conditions specified in TS ISO 8528/1, 8528-4, 8528-5, 8528-8, BS5000, ISO 3046/1:1986, NEMA MG-1.22.1, BS 5514/1.

STAND BY POWER RATING (ESP):

ESP is applicable for supplying emergency power for the duration of the utility power outage. No overload capability is available for this rating. Under no condition is an engine allowed to operate in parallel with the public utility at the Stand By Power rating. This rating should be applied where reliable utility power is available. A Stand By rated engine should be sized for a maximum of an 70% average load factor and 200 hours of operation per year. This includes less than 25 hours per year at the Stand By Power rating.

Stand By ratings should never be applied except in true emergency power outages. Negotiated power outages contracted with a utility company are not considered an emergency.

PRIME POWER RATING (PRP):

Applicable for supplying electric power in lieu of commercially purchased power. Prime Power applications must be in the form of one of the following two categories:

UNLIMITED TIME RUNNING PRIME POWER (ULTP):

PRP (Prime Power) is available for an unlimited number of hours per year in a variable load application. Variable load should not exceed a 70% average of the Prime Power rating during any operating period of 250 hours. The total operating time at 100% Prime Power shall not exceed 500 hours per year. A 10% overload capability is available for a period of 1 hour within a 12-hour period of operation. Total operating time at the 10% overload power shall not exceed 25 hours per year.

LIMITED TIME RUNNING PRIME POWER (LTP):

LTP (Limited Time Prime Power) is available for a limited number of hours in a nonvariable load application. It is intended for use in situations where power outages are contracted, such as in utility power curtailment. Engines may be operated in parallel to the public utility up to 750 hours per year at power levels never to exceed the Prime Power rating. The customer should be aware, however, that the life of any engine will be reduced by this constant high load operation. Any operation exceeding 750 hours per year at the Prime Power rating should use the Continuous Power rating.

CONTINUOUS POWER RATING (COP):

COP is the power that the engine can continue to use under the prescribed speed and the specified environment condition in the normal maintenance period stipulated in the manufacturing plant. And Continuous Power is applicable for supplying utility power at a constant 100% load for an unlimited number of hours per year. No overload capability is available for this rating.

PRODUCED BY AN AUTODESK EDUCATIONAL PRODUCT

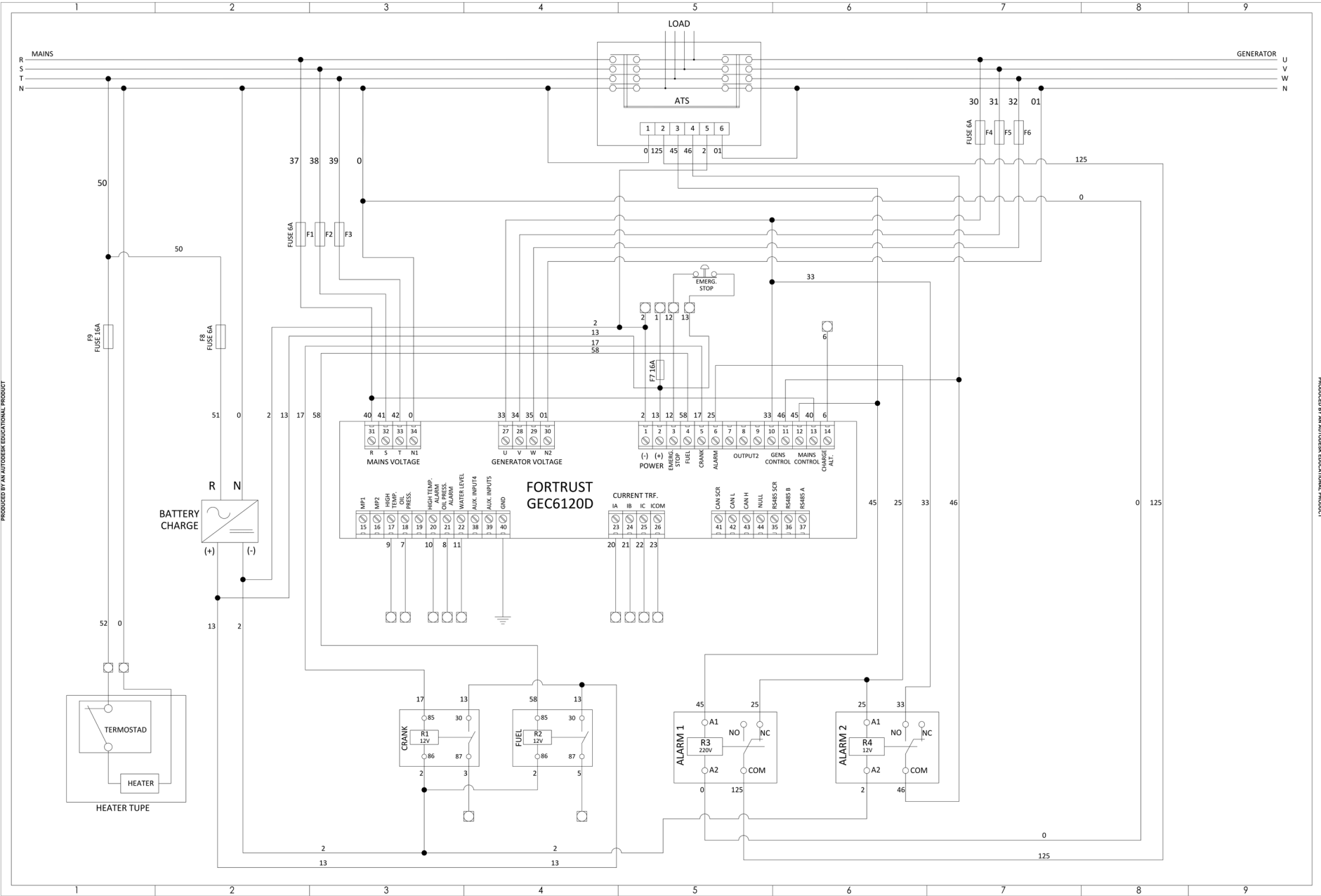

PRODUCED BY AN AUTODESK EDUCATIONAL PRODUCT

PRODUCED BY AN AUTODESK EDUCATIONAL PRODUCT

PRODUCED BY AN AUTODESK EDUCATIONAL PRODUCT

* ITS POWER GENERATORS reserve its right to change the specifications and cabin sizes in advance due to the continuing developments in the generator technology without any prior notification.



ITS | **POWER**[®]
GENERATORS

Gümüşsuyu Cd. No. 32/25 Maltepe Mh. 34010 Zeytinburnu / İSTANBUL

T. 0090 533 7429956